

Key to Navjeevan Term Book - I

Standard
1

Teacher's Copy

**NAVJEEVAN PUBLICATIONS PVT. LTD.
EDUCATIONAL PUBLISHERS**



MUMBAI

4940/1B, Dhobiwadi, Dr. Jaykar Marg, Opp. Datta Mandir, Thakurdwar,
Mumbai - 400 002.

Only Calling: 8291852601

Calling & Whatsapp: 9322531798 / 8291852631 / 8291972352

Website: www.navjeevanpublications.com

Enquiries: info@navjeevanpublications.com

Sales: acc.nppl@gmail.com

PUNE

470 /471, Raviwar Peth, Nandan Residency, 1st Floor,
Phadke Haud, Pune - 411 002.

Tel.: (020) 24432951 / 7066835645

CONTENTS

Sr. No.	Subject Name	Pg. No.
1.	English Balbharati	3 to 9
2.	English Grammar & Composition	10 to 16
3.	Mathematics	17 to 22
4.	Play Do Learn	23 to 27

BOOK 1

English Balbharati

Unit One – 1. A Happy Song

CLASSWORK

1.  - Butterfly  - Moon  - Flower

2. (1 - c) (2 - d) (3 - a) (4 - b)

2. Nature

CLASSWORK

1. a. nature b. free c. bleue d. beauty

ACTIVITY

1. a. rainbow b. trees c. clouds





3. Action Time

CLASSWORK

1. (1 - d) (2 - a) (3 - e) (4 - b) (5 - c)

4. Know Each Other

CLASSWORK

1.    
 Good Morning Good Afternoon Good Evening Good Night

5. Let's Learn Alphabet

CLASSWORK

1. a. a, d, k, w, y b. B, E, J, S, Y c. h, j, m, p, q

2. (1 - c) (2 - d) (3 - e) (4 - a) (5 - b)







HOMEWORK

1. A, P, K, V, D, O

2.

1.	a	a <u>p</u> ple	a <u>n</u> t	a <u>x</u> e	a <u>i</u> rpl <u>a</u> ne
2.	b	b <u>u</u> tterfly	b <u>u</u> tter	b <u>e</u> d	b <u>e</u> a <u>u</u> tif <u>u</u> l
3.	m	m <u>o</u> nkey	m <u>a</u> t	m <u>o</u> ney	m <u>o</u> m <u>e</u> nt
4.	l	l <u>a</u> ke	l <u>i</u> tt <u>l</u> e	l <u>o</u> ve	l <u>i</u> ke

ACTIVITY

1.  - T  - D  - E
 4.  - C  - H  - C

6. Make Words













CLASSWORK

1. 1. den, hen, men, pen, ten 2. pin, tin, bin, fin, win
 3. bow, cow, how, now, wow 4. fun, run, sun, bun

HOMEWORK

1. 1. life 2. summer 3. teacher
 4. cook 5. cotton

ACTIVITY

1. 1.    
 2.    
 3.    

2. 1. bat bed boat **hut**
 2. sun **lock** sack soap
 3. cock cat **dog** clap
 4. ladder leaf **rose** lemon
 5. **key** pot pen purse
 6. top toy **axe** tree

8. Sounds in the Middle of Words

ORAL

1. 1.

b
c a t
g

 bag
 cat
 2.

j
f a t
m

 jam
 fat
2. 1.

p
t i n
n

 pin
 tin
 2.

f
b u n
n

 fun
 bun
 3.

b
c o w
y

 boy
 cow
 4.

d
p e n
n

 den
 pen

CLASSWORK

1. 1. c a b 2. h e n 3. p i n 4. p o t 5. g u n

A		B	
1. vase	————	a. hat	————
2. house	————	b. doll	————
3. duck	————	c. van	————
4. yell	————	d. tap	————
5. rope	————	e. yolk	————
6. tree	————	f. ring	————

















9. Soham's Ball

CLASSWORK

1.  excuse me  thank you  happy  angry

10. Things that go Together

CLASSWORK

1.  cup  table  ball  paint
 chair  brush  saucer  bat
 umbrella  hen  lock  pencil
 egg  key  notebook  rain
2. 1. socks 2. ink 3. milk
 4. window 5. shuttlecock 6. swimming ring

HOMEWORK

1. (1 - e) (2 - h) (3 - a) (4 - g)
 (5 - b) (6 - d) (7 - f) (8 - c)

11. Number Song

CLASSWORK

1. 1. one 2. two 3. three 4. four 5. five
 6. six 7. seven 8. eight 9. nine 10. ten

2. 1. - 3 2. - 7 3. - 9 4. - 5

3. 

4. 1. more 2. gate

Unit Two – 1. Rain

CLASSWORK

1. sea
1. The rain falls on the field and tree.
2. We see the ship at sea.

HOMEWORK

1. umbrellas, ship, trees, rain, clouds, field, sea

2. Things in my Classroom

CLASSWORK

- | | | | |
|--|--|---|--|
| 
book | 
pencil | 
crayons | 
duster |
| 
chalk | 
bag | 
tiffin | 
ruler |
| 
compass box | 
sharpener | 
eraser | 
slate |

HOMEWORK

1. t a b l e 2. ch a l k 3. ch a i r
4. d u s t e r 5. d o o r 6. ch a r t
7. b e n ch 8. d u s t b i n 9. b l a c k b o a r d
10. c u p b o a r d

3. Colours

CLASSWORK

1. [To be done by students with teacher's help.]

1. trees 2. sky 3. silk
1. grass 2. sky 3. banana 4. apple
5. flower 6. carrot 7. pigeon 8. grapes

HOMEWORK

- V stands for Violet I stands for Indigo
B stands for Blue G stands for Green
Y stands for Yellow O stands for Orange
R stands for Red

ACTIVITY

1. ducks, balloon, tree, house, pond, mountains, sun, flowers

4. Magic Seed

CLASSWORK

1. wide 2. fig 3. tree
1. [To be done by students with teacher's help.]

5. Who are you?

CLASSWORK

1. green 2. white 3. red 4. green
1. [To be done by students with teacher's help.]
2. spinach, ladyfinger
3. chilly, garlic

ACTIVITY

- [To be done by students with teacher's help.]
- [To be done by students with teacher's help.]

6. Be Quick

CLASSWORK

- | | | | |
|----------------|---------------|-----------|----------|
| 1. 1. Tomato | 2. Potato | 3. Radish | 4. Onion |
| 5. Cauliflower | 6. Ladyfinger | 7. Carrot | 8. Peas |

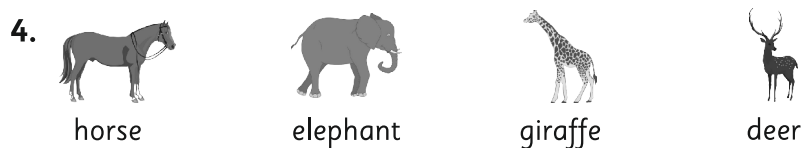

English Grammar & Composition

1. Capital Letters and Small Letters

Formative Assessment

Class Work

- | | | |
|-----------------------|----------------------|------------------------|
| 1. LEAF - leaf | GIRL - girl | KITE - kite |
| DOLL - doll | CHAIR - chair | BOOK - book |
| HORSE - horse | FLAG - flag | BANANA - banana |
| PLATE - plate | | |
-
- | | |
|-------------------------|----------------------------|
| 2. train - TRAIN | elephant - ELEPHANT |
| moon - MOON | tree - TREE |
| goat - GOAT | umbrella - UMBRELLA |
| road - ROAD | quill - QUILL |
| tray - TRAY | window - WINDOW |

2. Vowels and Consonants

Formative Assessment

Activity

1.

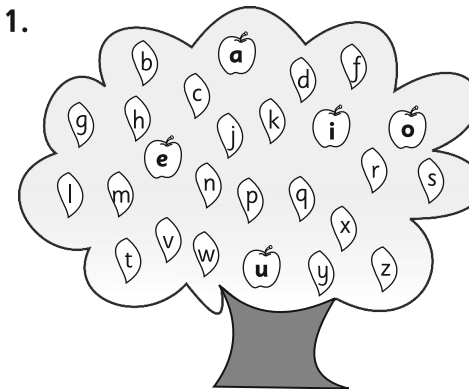

Write the vowels -
a, e, i, o, u

Write the consonants -
b, c, d, f, g, h, j, k, l, m, n, p,
q, r, s, t, v, w, x, y, z

Class Work















- | | | | |
|---|-------------------------------------|---|--|
| 1. <u>b</u> <u>a</u> <u>l</u> <u>l</u> | <u>p</u> <u>e</u> <u>n</u> | <u>o</u> <u>r</u> <u>a</u> <u>n</u> <u>g</u> <u>e</u> | <u>h</u> <u>o</u> <u>u</u> <u>s</u> <u>e</u> |
| <u>s</u> <u>h</u> <u>o</u> <u>e</u> <u>s</u> | <u>l</u> <u>e</u> <u>a</u> <u>f</u> | <u>t</u> <u>a</u> <u>b</u> <u>l</u> <u>e</u> | <u>c</u> <u>a</u> <u>k</u> <u>e</u> |
| <u>i</u> <u>c</u> <u>e</u> <u>c</u> <u>r</u> <u>e</u> <u>a</u> <u>m</u> | <u>a</u> <u>x</u> <u>e</u> | <u>c</u> <u>u</u> <u>p</u> | <u>a</u> <u>e</u> <u>r</u> <u>o</u> <u>p</u> <u>l</u> <u>a</u> <u>n</u> <u>e</u> |
| <u>b</u> <u>e</u> <u>a</u> <u>r</u> | <u>r</u> <u>o</u> <u>s</u> <u>e</u> | | |

2. ship moon bell
nose zebra pencil
owl truck bowl

3. Use of A / An

Formative Assessment

Assignment

2.  An ant  A bat  A temple  An engine
 A bird  An egg  A flower  A jeep
 An igloo  An onion  A cow  An inkpot
 An umbrella  A hen  A fan





Activity

2. an orange an apple a tree a girl
a boy an aeroplane a doll an ice-cream
a puppy

4. Naming Words

Formative Assessment

Class Work

1.  jug  king  school  camel



bread



park



doctor



dog



book



vehicles



baby



tiger



coat



hospital



fish

2. **People** - king, doctor, baby
Places - school, park, hospital
Animals - camel, dog, tiger, fish
Things - jug, bread, book, coat, vehicles

4. Naming Words

Formative Assessment

boys, puppy, flower, slide, girls, fountain, swing, plants, mother, trees, birds, clouds

Activity

1, 3, 4, 6

2, 5, 7

5. Alphabetical Order

Formative Assessment

Assignment

1. (1) D, J, M, P (2) A, E, Q, S (3) C, F, K, P
(4) b, g, i, t (5) h, l, n, z
1. (1) bear, cat, dog, lion
(2) Amit, Jai, Roy, Sam
(3) bat, car, doll, jeep

- (4) apple, chickoo, mango, orange
- (5) aunt, father, mother, uncle
- (6) book, crayon, pen, school
- (7) blue, green, red, yellow
- (8) crow, dove, eagle, hen
- (9) bed, chair, desk, table
- (10) brother, father, mother, sister

6. Use of 'This is' / 'That is'

Formative Assessment

Assignment

- (1) This is a bird.
 - (2) That is a car.
 - (3) That is a brush.
 - (4) This is a bat.
 - (5) That is a monkey.
 - (6) This is a table.
 - (7) That is a tree.
 - (8) That is a boat.
 - (9) This is a puppy.
 - (10) That is a kite.
- This is - 1, 4, 5 That is - 2, 3

7. One And More Than One

Formative Assessment

Class Work

One (Singular)	More than One (Plural)
(1) a ball	balls
(2) a kite	kites
(3) a girl	girls
(4) a pencil	pencils
(5) an egg	eggs
(6) a cap	caps
(7) a book	books
(8) a bird	birds
(9) a table	tables
(10) a frock	frocks

- (11) a duck ducks
- (12) a balloon balloons
- (13) an orange oranges
- (14) a cake cakes
- (15) an elephant elephants

8. Picture Comprehension

Formative Assessment

Class Work

classroom, door, window, benches, desks, table, duster, chalks, blackboard, chart, dustbin

9. Use of 'These are' / 'Those are'

Formative Assessment

- (1) These are dolls.
 - (2) Those are chalks.
 - (3) Those are cats.
 - (4) These are beds.
 - (5) Those are roses.
 - (6) These are clouds.
 - (7) Those are bottles.
 - (8) Those are ants.
 - (9) These are stars.
 - (10) These are houses.
 - (11) Those are clocks
 - (12) These are pots.

10. Action Words - Verbs

Formative Assessment

Assignment



walk

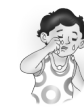

cry



study



run



work



sleep



listen



fly



play



laugh

Action Words - Verbs

Summative Assessment

1. (1) Rohan plays in the garden.
- (2) Anju talks over the phone.
- (3) My father reads the newspaper.
- (4) Grandmother goes to the temple everyday.
- (5) I sleep at nine o'clock.
- (6) The bird sings sweetly.
- (7) The dog barks loudly.
- (8) Meena eats an apple.
- (9) Avin fights with his friends.
- (10) The sun rises every morning.

2.

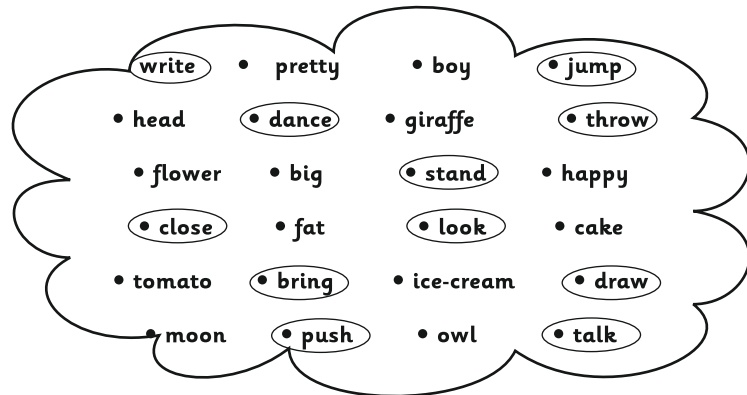

11. Picture Composition

Formative Assessment

Class Work

reads, cooks, plays, throws, catches, sits, watches, sleeps, jumps, feeds.

12. Comprehension

Summative Assessment

~~beach~~ ~~plants~~ ~~slide~~ ~~sitting~~ ~~sitting~~

~~sleeping~~

~~butterflies~~

~~seesaw~~

~~swing~~

13. Pronouns : He / She / It

Formative Assessment

Assignment

1. (1) This is Mr. Ved. He is a doctor.
- (2) Look at Rima. She is going to school.
- (3) The brown bird sat on the tree. It has a nest on the tree.
- (4) Mother is sleeping. She is not well.
- (5) This is my bag. It is very heavy.
- (6) Uncle Tom has a car. It is red.
- (7) Rafi sells fruit. He is selling apples.
- (8) I saw a lion in the circus. It sat on the tall stool.
- (9) Fanny is my friend. She is a clever girl.
- (10) The squirrel ran up the tree. It had a bushy tail.

14. Opposites

Formative Assessment

Class Work



big x small



laugh x cry



tall x short



hot x cold

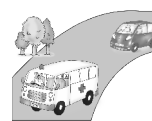

front x behind



stand x sit

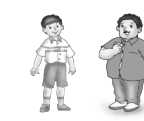

thin x fat



slow x fast



fall x rise



come x go

Mathematics

Part - I 1. Small - Big

Classwork

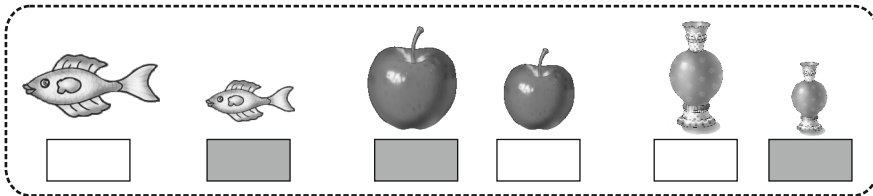

Homework

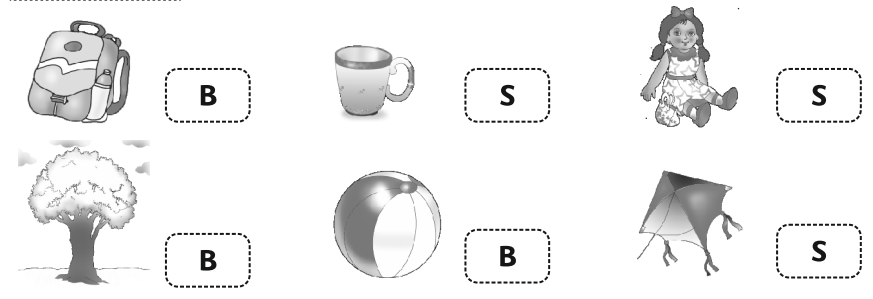

2. Behind - In Front of

Classwork

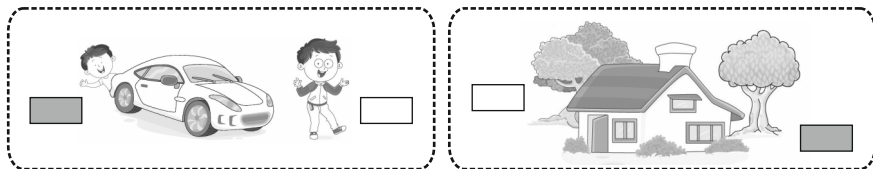

Homework

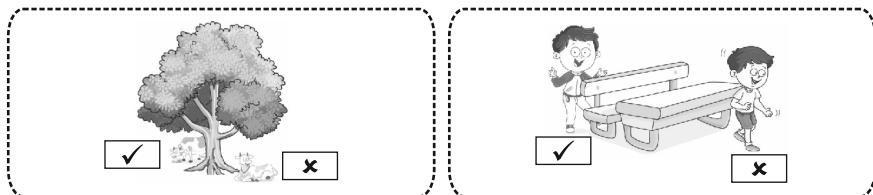

3. Above and Below

Classwork

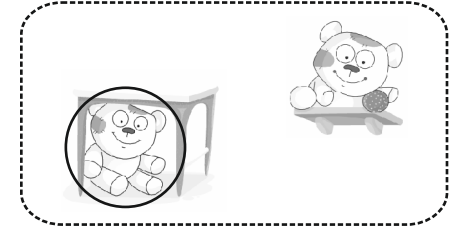
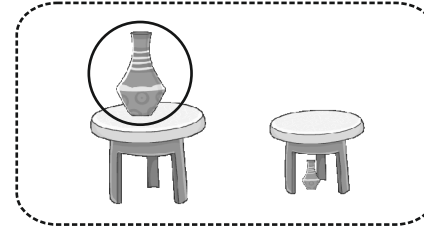

Homework

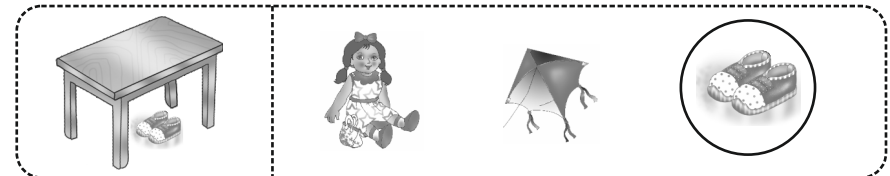
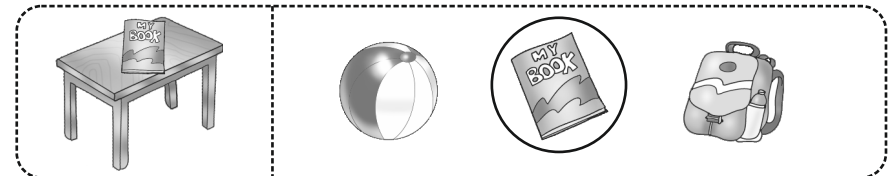

5. One - Many

Classwork



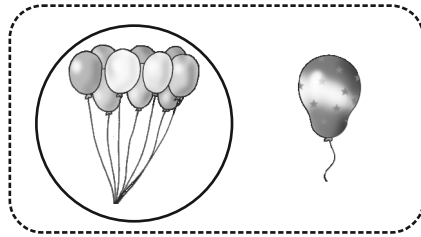
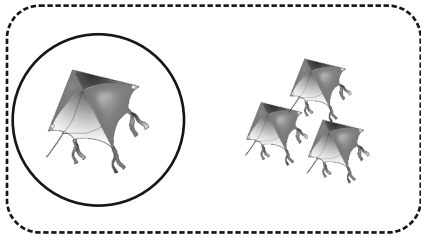

Homework

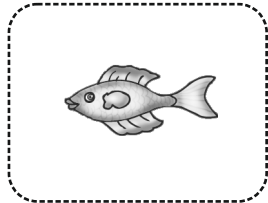

O

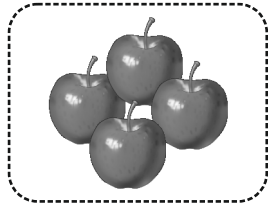

M

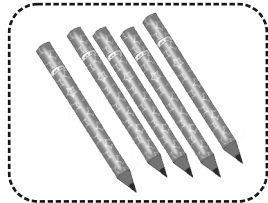

M



M



M

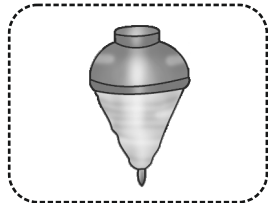

O

6. Find the Difference

Classwork

[To be done by students.]

7. Understand and Write 1

Activity

Colour the nose, mouth and tongue.

8. Understand and Write 2

Activity

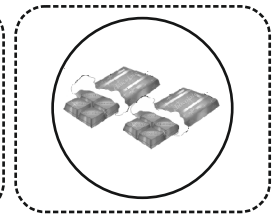
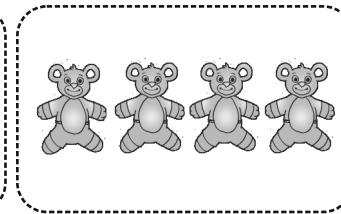
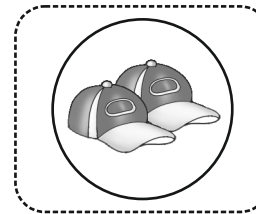

9. Understand and Write 3

Classwork

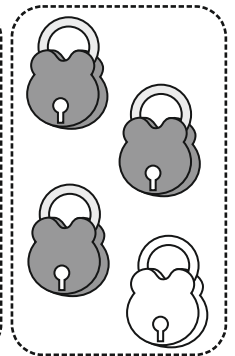
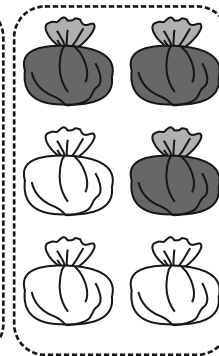
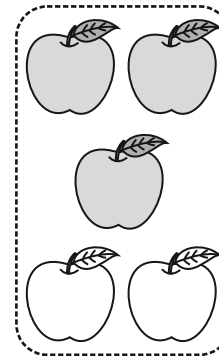

Activity

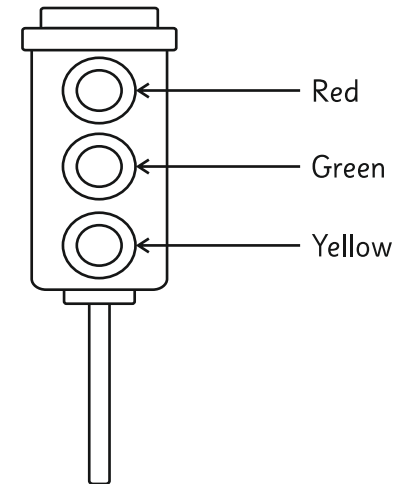

10. Understand and Write 4

Activity



11. Understand and Write 5

Classwork

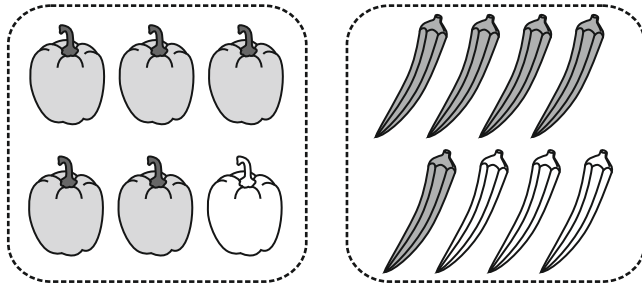

12. Understand and Write 6

Classwork

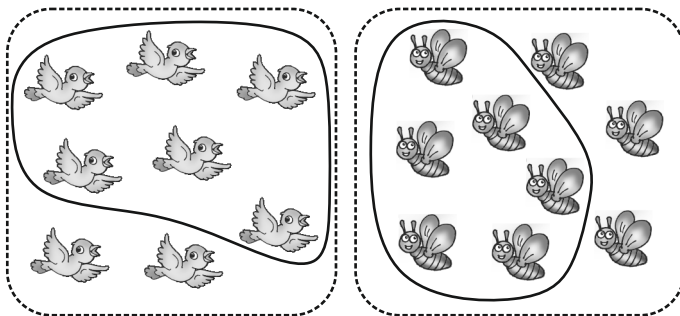

Activity

[To be done by students.]

13. Understand and Write 7

Classwork

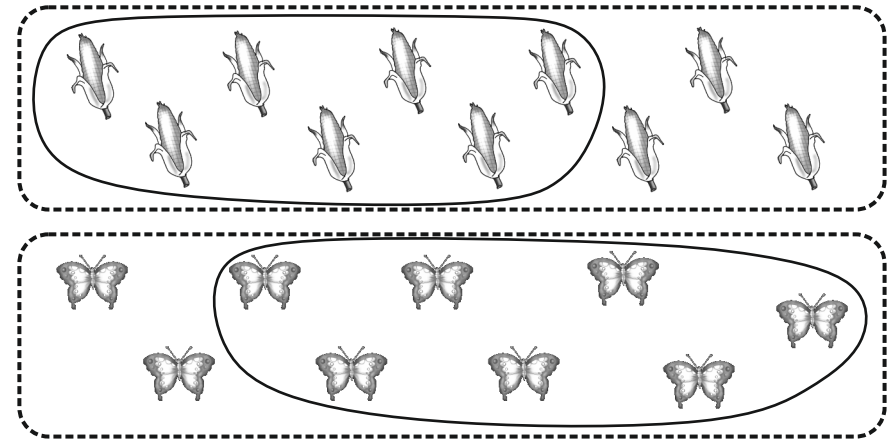

Activity

[To be done by students.]

Play Do Learn

Play - 1. Health

1.1 My Daily Routine

1.  8 Eating food

 2 Washing hand

 7 Going to School

 4 Taking a bath

 5 Wear clean clothes

 9 Studying

 6 Combing hair

 1 Rising early

 10 Helping in household work

 3 Brushing teeth

 11 Playing games

 12 Sleeping

2. 2, 4, 5 1, 3



The boys are playing football. They are playing on a big ground.



This is toothpaste and toothbrush. We use it to brush our teeth.

4. [To be done by students with teacher's help.]

1.2 Diet

4. (1) I eat with my mouth open / closed.
- (2) I like to talk / be quiet when I eat.
- (3) I like to run / stand when I drink milk.
- (4) I wash my legs / hands before eating.

- (5) I must drink a lot of water / cola.
- (6) I eat breakfast in the morning / afternoon.
- (7) After I come back from school in the evening. I have snacks / lunch.

3. [To be done by students with teacher's help.]

1.3 Cleanliness

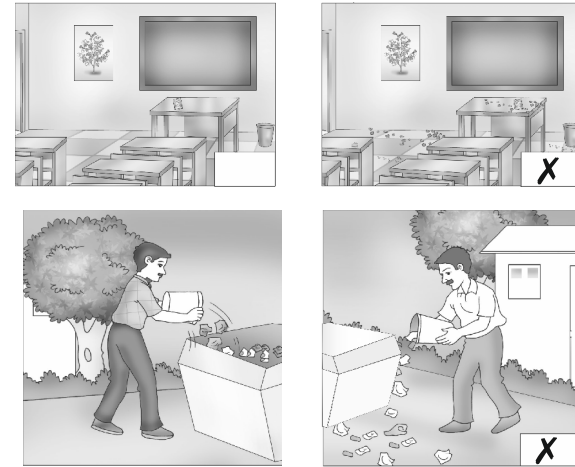

Do - 1. Need Based Activities

1.2 World of Work

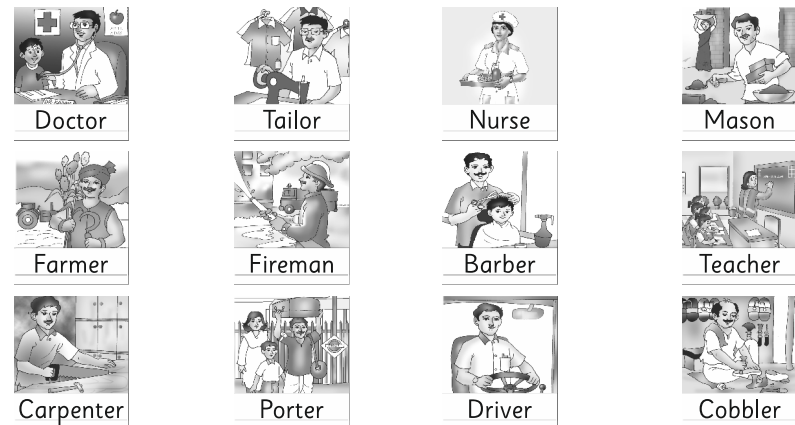

2.

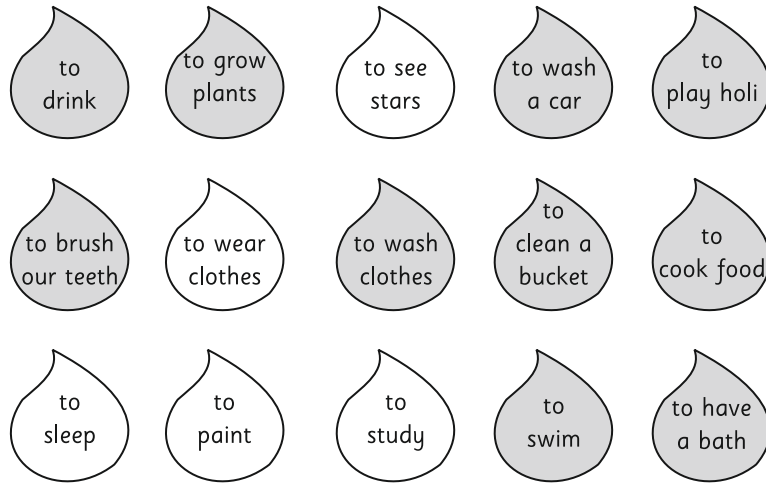

(C) Disaster Management

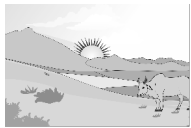

Sunrise

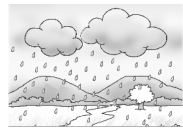

Rain



River



Night



Lightning

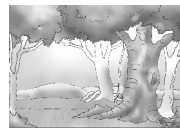

Forest

Story formation with the help of pictures

1.



2. The sky was dark and the clouds were grey. After some time the rain started. There was heavy rain. Soon the roads started to flood. After sometime there were trees fallen.